

SOUNDVISION TECHNOLOGIES // TRUAUDIO // VSSL // 2023







Soundvision Technologies brings together its founding brand, TruAudio, with its other premier brands VSSL, Current Audio, Forge, and Unified Copper, to provide ultimate flexibility alongside the innovation and quality you have come to expect. Soundvision Technologies is a global manufacturer of architectural, outdoor, and commercial speakers, subwoofers, sound systems, and Native Streaming™ audio system amplifiers.



TECHNICAL TERMS

Frequency Response: Audible frequency range that a speaker can reproduce and is measured in Hertz (Hz).

Power: Electrical power transferred from an audio amplifier to a loudspeaker, measured in watts. The electrical power that the loudspeaker receives, combined with its efficiency, determines the sound power generated.







Sensitivity: General measure of how loud a speaker can be (in decibels per 1 watt per 1 meter in distance) in relation to how high the volume, or output, needs to be on your amplifier. The higher the sensitivity number, the less power required to play your speakers optimally.

Impedance: A measure of how much the speaker resists current. The lower the impedance in ohms, the more power the speaker will draw from your receiver. This refers to the load that a speaker places on the amplifier and helps determine the compatibility between the amplifier and speakers. Speakers are rated based on the number of ohms that they have (typically between 4 and 8 ohms).

FAMILY ICONS

To ease the process of matching products and materials, TruAudio has incorporated a family icon designation on all of our current and future products. These icons will help you identify which products can be paired together to make an optimal system for your customers.

Each family is assigned an icon based on voicing, timbre matching, and materials. This system allows you to mix and match different series and types of speakers within the same family while remaining confident you are getting the best possible output between all of the speakers.

ICON	PRODUCTS IN FAMILY
	<ul style="list-style-type: none"> • S63 • S63i • W12 • SC12
	<ul style="list-style-type: none"> • ELITE26 • ELITE46 • ELITE26-BS • ELITE26-CC • ELITE46-TOWER • G71 • GD71 • G91 • REV71 • REV71SUR • SB-CPSB-C • SB-CUSTOM-LC • SB-CUSTOM-SC
	<ul style="list-style-type: none"> • PG-8 • PG-6
	<ul style="list-style-type: none"> • G72 • GD72 • G92 • GHT-66P • GHT-SUR-P • GPW-6 • GPW-8 • GHT-55P • PDP-6 • PDP-8 • PP-4 • PP-6 • PP-8 • REV72 • REV72SUR • SB-CUSTOM-LP • SB-CUSTOM-SP • SB-CPSB-P • SB-SLIM-44P
	<ul style="list-style-type: none"> • IWP-6
	<ul style="list-style-type: none"> • SP-8 • SP-6
	<ul style="list-style-type: none"> • AS-1 • AS-2 • AS-3 • AS-360 • BD-8 • BP-SUB-12 • CL-70v-6 • CL-70v-6UL • cSUB Series • HS-SUB-12 • IC-SUB-8 • OL-70v-6 • OL-5 • OP6 • RK-8
<p>Compatible with any family</p>	

VSSL®



NATIVE STREAMING™



Chromecast built-in



Alexa Cast

STREAM FROM APPS YOU ALREADY KNOW AND USE
NO THIRD PARTY APPS NECESSARY



THE POWER OF VOICE CONTROL

GOOGLE ASSISTANT | SIRI | ALEXA

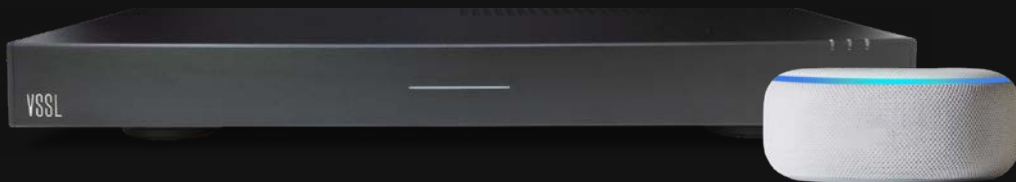

DRIVERS



SET YOUR MUSIC FREE™



RESIDENTIAL DISTRIBUTED AUDIO

Homeowners can now walk into their home, use their phone and open their favorite music service app. Playlist pulled up and playing, the homeowner effortlessly finds the name of the room they want to play music in with two button clicks and boom, their music has been set free. The VSSL A.6x is wired up directly to twelve TruAudio G91 speakers to provide six rooms of music bliss.

COMMERCIAL

The business owner wants to assure music is always on and playing in key areas of his office during business hours, but doesn't want to pay for an expensive automation system to make it happen. The lobby, the showroom and the design center are his areas of focus. The VSSL A.3x is wired up directly to a pair of TruAudio Beat Drops in the lobby, a pair of PP-6 in the showroom and a pair of PP-6 in the design center. Leveraging Google Routines, the business owner can now assure his clients are enjoying music as they make buying decisions.



A.6x

Zones: 6
Channels: 12
Output Power: 50 watts/ch @8/4Ω
Inputs: (6) matrixed analog, (1) optical, (1) IR, (1) network
WiFi Audio: AirPlay 2 / Chromecast built-in
 Spotify Connect / Alexa Cast
WiFi: N/A
Outputs: (6) matrixed analog, (1) network
EQ: 7-band adjustable
Sub Out: ---
S/N Ratio: >101 dB
Frequency Response: 20Hz - 50kHz
Operating Voltage: 115-230 VAC 50/60 Hz auto switch
Rack Space: 2U
Dimensions No Feet: 17" W x 3.46" H x 14" D
Dimensions With Feet: 17" W x 4.7" H x 14" D



A.3x

Zones: 3
Channels: 6
Output Power: 50 watts/ch @8/4Ω
Inputs: (3) matrixed analog, (1) optical, (1) IR, (1) network
WiFi Audio: AirPlay 2 / Chromecast built-in
 Spotify Connect / Alexa Cast
WiFi: N/A
Outputs: (3) matrixed analog, (1) network
EQ: 7-band adjustable
Sub Out: ---
S/N Ratio: >101 dB
Frequency Response: 20Hz - 50kHz
Operating Voltage: 115-230 VAC 50/60 Hz auto switch
Rack Space: 1U
Dimensions No Feet: 17" W x 1.72" H x 10.6" D
Dimensions With Feet: 17" W x 2.42" H x 10.6" D



A.1x

Zones: 1
Channels: 2
Output Power: 35 watts @ 8Ω RMS, 50 watt @ 4Ω RMS
Inputs: (1) analog, (1) optical, (1) digital coax, (1) IR, (1) network
WiFi Audio: AirPlay 2 / Chromecast built-in
 Spotify Connect / Alexa Cast / Bluetooth
WiFi: 2.4/5.0 GHz dual antenna MIMO
Outputs: (1) analog, (1) optical, (1) digital coax, (1) network
EQ: 7-band adjustable
Sub Out: RCA, adjustable cross over 55-200 Hz or by-pass for full range
S/N Ratio: >98 dBA-weighted
Frequency Response: 20Hz - 20kHz
Operating Voltage: 115-240 VAC 50/60 Hz auto switch
Rack Space: 1U
Dimensions No Feet: 7.44" W x 1.69" H x 8.69" D
Dimensions With Feet: 7.44" W x 2" H x 8.69" D

VSSL.

SX SERIES



5.1

WIRELESSLY PAIR TWO SX SPEAKERS WITH A SX SOUNDBAR AND SX SUBWOOFER TO CREATE AN IMMERSIVE 5.1 SURROUND SOUND EXPERIENCE.

BMR

BALANCED MODE RADIATORS (BMRs) COMBINE BENDING WAVE MODE TECHNOLOGY WITH PISTONIC MOTION TO CREATE FULL AUDIO RANGE, WIDE DIRECTIVITY SPEAKER DRIVERS FOR CRYSTAL CLEAR HIGHS AND LOWS.



NATIVE STREAMING™ IS THE SIMPLEST WAY TO STREAM YOUR MUSIC TO YOUR AUDIO SYSTEM. STREAM FROM APPS YOU ALREADY KNOW. NO THIRD PARTY APPS NECESSARY.

VSSL

VSSL



SX SOUND BAR

Speakers: 3 wide-dispersion BMR drivers
Woofers: 2 active down-firing woofers
Amplifier: X Class-D digital amplifiers
System Requirements: TV with HDMI ARC or optical digital audio output, broadband internet and the VSSL App
Wireless Connectivity: Connects to WiFi network with any 802.11 b/g/n, 2.4GHz broadcast-capable router
EQ: Advanced EQ settings
Ethernet Ports: (2) 10/100 Mbps Ethernet ports

Room Correction: Dynamically tunes the soundbar to the unique acoustics of the room or area (iOS device required)
Power Supply: Auto-switching 100-240V ~50-60 Hz 2 A AC universal input
Weight: 18.2 lbs
Dimensions: L: 42" (1067mm) x W: 6" (154mm) H: 3.3" (84mm)
Multiple Orientations: Tabletop or wall mounted
Control: TV remote or VSSL App

SX SPEAKER

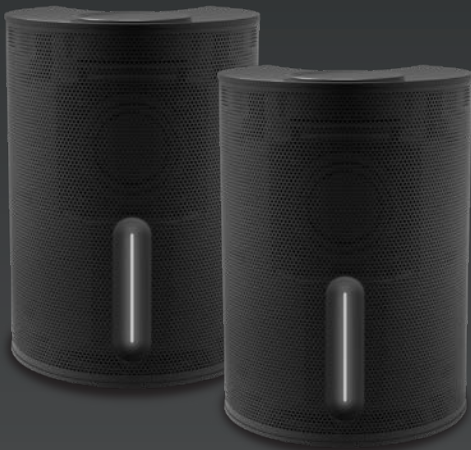

Speakers: 1 wide-dispersion BMR driver
Woofers: 1 active down-firing 4" woofer
Stereo Pair: Turn two speakers into separate left and right channel speakers
Home Theater: Add two SX Speakers as surrounds to a SX Soundbar
Stream: AirPlay2, Google Cast, Alexa Cast, and Spotify Connect
Voice: Compatible and controllable with Siri, Google Assistant, and Alexa
Wireless Connectivity: Connects to WiFi network with any 802.11 a/b/g/n, 2.4 or 5 GHz broadcast-capable speaker
EQ: Advanced EQ settings
Ethernet Ports: (2) 10/100 Mbps Ethernet ports
Room Correction: Dynamically tunes the soundbar to the unique acoustics of the room or area (iOS device required)
Power Supply: Auto-switching 100-240V ~50-60Hz 2 A AC universal input
Weight: 4.6 lbs
Dimensions: H: 7.9" (202mm) x W: 5.7" (145mm) D: 5.8" (149mm)
Multiple Orientations: Tabletop placement or wall mounted with .25"-20 thread universal mount

SX SUBWOOFER



Speakers: 10" Honeycomb
Amplifier: Class-D digital amplifier
Dual Acoustic Ports: Tuned to enhance subwoofer performance
All Digital Sound: All filter settings, active equalization, and time alignment are done digitally through DSP circuitry for zero-loss audio quality and energy
EQ: Advanced EQ settings
Ethernet Ports: (2) 10/100 Mbps Ethernet ports (optional)
Wireless Connectivity: Connects to any SX Soundbar or SX Speaker
Power Supply: Auto-switching 100-240V ~50-60 Hz 2 A AC universal input
Weight: 29.8 lbs
Dimensions: L: 21.7" (550mm) x W: 16.9" (431mm) H: 4.4" (111mm)
Multiple Orientations: Fix in stand upright or lay flat



SET YOUR MUSIC FREE™



SELECT SERIES™

S63 | S63i

OFFSET TRIPLE TWEETER ARRAY

LONG THROW DRIVERS

MMAG DRIVERS

BI-WIRE (S63 ONLY)



S63

Speaker Type: Bookshelf cabinet, bi-wire sealed LCR

Woofer: (2) 6.5" extreme high excursion MMAG mid bass drivers

Tweeter: (3) 1" triple array silk soft dome

Power: 300 watts

Impedance: 8Ω

Freq Response: -3dB down point 58Hz

Sensitivity: 87dB

Grill Type: Aluminum, frameless

Finish: Black brushed aluminum

Cutout Dims: N/A

Finish Dims: H: 19" (482mm) x L: 9.9" (251.5mm) x W: 10" (254mm)



S63i

Speaker Type: In-wall LCR

Woofer: (2) 6.5" extreme high excursion MMAG mid bass drivers

Tweeter: (3) 1" triple array silk soft dome

Power: 300 watts

Impedance: 8Ω

Freq Response: -3dB down point 58Hz

Sensitivity: 87dB

Grill Type: Aluminum, frameless

Finish: Black brushed aluminum

Cutout Dims: H: 17.27 (438.7mm) x W: 8.27" (210.05mm)

Finish Dims: H: 18.8" (478.5mm) x W: 9.84" (249.9mm) x D: 3.9" (99.1mm)





SELECT SERIES™

W12 | SC12

AXIALLY
ALIGNED
OPPOSING
12" DRIVERS

EXTENDED 3"
PEAK-TO-PEAK
CONE TRAVEL

ICE
POWER
AMP

MULTIPLE
FINISHES

12"
DRIVER

STANDARD
OR DIAMOND
ORIENTATION



W12

Speaker Type: Dual 12" powered subwoofer
Woofers: (2) 12" axially aligned opposing with 3" excursion
Power: 700 watts
Freq Response: F3 of 22Hz
Amp Protection: ICE power
Controls: Gain, LF adjust, crossover, delay, 12V trigger
Inputs: (1) LFE, (1) RCA, (1) XLR
Outputs: (1) XLR
Cabinet Finish: Satin black
Cabinet Dims: H: 23.96" (606.2mm) x L: 20.23" (513.9mm) x W: 16.3" (414.3mm)



SC12

Speaker Type: 12" powered subwoofer
Woofers: 12" aluminum with 3" excursion
Power: 350 watts
Freq Response: F3 of 22Hz
Amp Protection: ICE power
Controls: Gain, LF adjust, crossover, delay, 12V trigger
Inputs: (1) LFE, (1) RCA, (1) XLR
Outputs: (1) XLR
Cabinet Finish: Satin black, white, oak, walnut, custom
Cabinet Dims: H: 15" (381mm) x L: 14" (356mm) x W: 14" (356mm)



ELITE

SERIES

TRUGRIP™
 PATENTED WITH SWARM TECHNOLOGY

New Toolless Design
 TruGrip technology, a 2-step mechanical dogear, ensures the tightest grip with zero sag.



ELITE46

Speaker Type:
Woofer:
Midrange:
Tweeter:
Power:
Impedance:
Freq Response:
Sensitivity:
Grill Type:
Rough-in Ring:
Finish Dims:

Cutout Dims:

Family:

In-wall, 3-way
 (3) 6.5" red carbon fiber
 (1) 6.5" carbon fiber
 1" titanium,
 250 watts
 8 Ω
 36 - 20k Hz (+/-3 dB)
 91 dB
 Microperf, frameless
 RW-E46/26
 32.4" (823 mm) L,
 10.0" (255 mm) W,
 4.0" (102mm) D,
 31.625" (803 mm) L,
 9.25" (235mm) W



ELITE26

In-wall, 3-way
 (2) 6.5" red carbon fiber

 1" titanium,
 200 watts
 8 Ω
 36 - 20k Hz (+/-3 dB)
 90 dB
 Microperf, frameless
 RW-E46/26
 19.4" (492 mm) L,
 10.0" (255 mm) W,
 4.0" (102mm) D,
 18.625" (472 mm) L,
 9.25" (235mm) W



ELITE46-TOWER

Speaker Type:
Woofer:
Midrange:
Tweeter:
Power:
Impedance:
Freq Response:
Sensitivity:
Grill Type:
Finishes:
Finish Dims:

Family:

Tower, 3-way
 (3) 6.5" carbon fiber
 (1) 6.5" carbon fiber
 1" titanium
 250W
 8Ω
 33-20kHz
 91 dB
 Black Cloth
 Black, Cherry, Maple, Walnut
 8" (203mm) L,
 10.25" (260mm) W,
 43" (1143mm) H



ELITE26-CC

Cabinet, 2-way
 (2) 6.5" carbon fiber

 1" titanium
 200W
 8Ω
 34-20kHz
 90 dB
 Black Cloth
 Black, Cherry, Maple, Walnut
 L: 19" (483mm) x
 W: 10.25" (260mm) x
 H: 8" (203mm)



ELITE26-BS

Bookshelf, 2-way
 6.5" carbon fiber

 1" titanium
 200W
 8Ω
 38-20kHz
 90 dB
 Black Cloth
 Black, Cherry, Maple, Walnut
 L: 8" (203mm) x
 W: 10.25" (260mm) x
 H: 12.75" (329mm)



OPTIONAL FINISHES

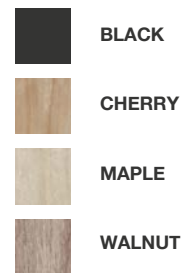

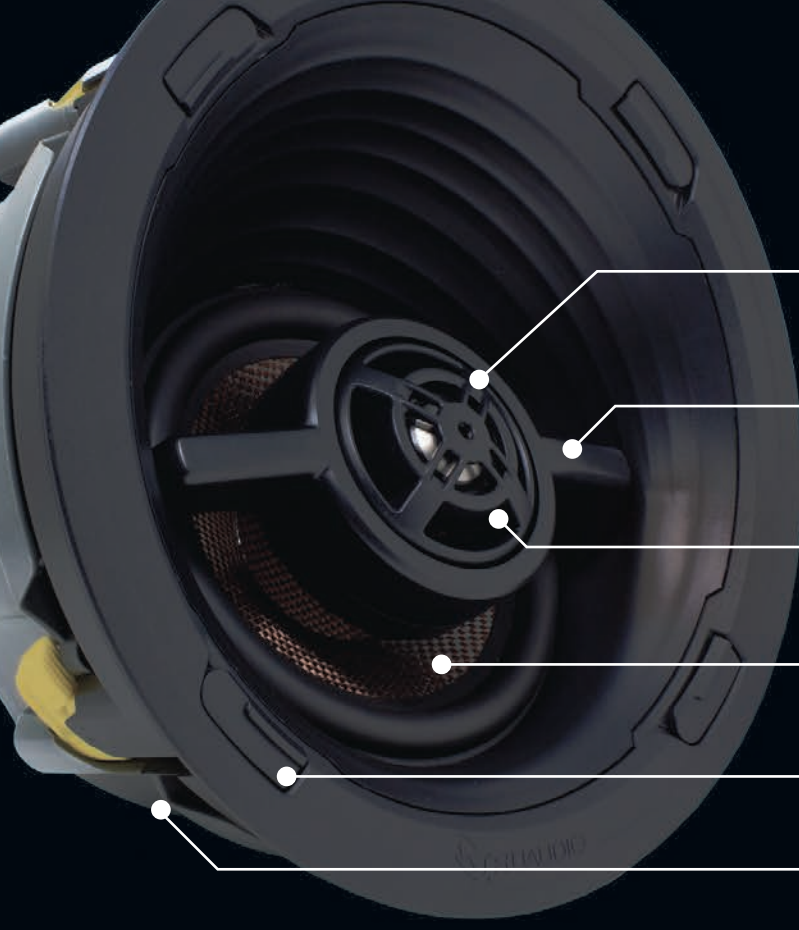

DIRECTIONAL TWEETER

ANGLED TWEETER BRIDGE HANDLE

3" MIDRANGE

7" ANGLED DRIVER

TRUGRIP TOOLLESS DESIGN

PROTECTIVE BACK BOX



Quick. Easy. Secure.

The fastest way to terminate a speaker. Connect speaker wire to rough-in ring during pre-wire, then use the Quick Connect cable to tether to the speaker's Quick Connect.



New Toolless Design

TruGrip technology, a 2-step mechanical dogear, ensures the tightest grip with zero sag.

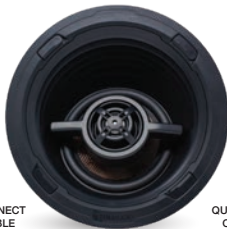

QUICK CONNECT COMPATIBLE



QUICK CONNECT COMPATIBLE



QUICK CONNECT COMPATIBLE



QUICK CONNECT COMPATIBLE

Speaker Type: In-ceiling angled, 3-way
Woofers: 7" woven carbon fiber
Midrange: 3" carbon fiber, swivel
Tweeter: 1" titanium, swivel
Power: 175 watts
Impedance: 8 Ω
Freq Response: 36 - 20k Hz (+/-3 dB)
Sensitivity: 92 dB
Grill Type: Microperf, frameless
Rough-in Ring: RC-879
Finish Dims: 10.5" (267 mm) diameter
 6.0" (152 mm) deep
Cutout Dims: 9.9" (251 mm) diameter

Family: GRAND CANYON

REV71SUR
 In-ceiling angled, surround
 7" woven carbon fiber

 (2) 1" titanium, swivel
 175 watts
 8 Ω
 36 - 20k Hz (+/-3 dB)
 92 dB
 Microperf, frameless
 RC-879
 10.5" (267 mm) diameter
 6.0" (152 mm) deep
 9.9" (251 mm) diameter

Family: GRAND CANYON

REV72
 In-ceiling angled, 3-way
 7" polypropylene
 3" polypropylene, swivel
 1" silk dome, swivel
 150 watts
 8 Ω
 38 - 20k Hz (+/-3 dB)
 91 dB
 Microperf, frameless
 RC-879
 10.5" (267 mm) diameter
 6.0" (152 mm) deep
 9.9" (251 mm) diameter

Family: POWELL

REV72SUR
 In-ceiling angled, surround
 7" polypropylene

 (2) 1" silk dome, swivel
 150 watts
 8 Ω
 38 - 20k Hz (+/-3 dB)
 91 dB
 Microperf, frameless
 RC-879
 10.5" (267 mm) diameter
 6.0" (152 mm) deep
 9.9" (251 mm) diameter

Family: POWELL

Optional:



Black Micro-Perf Frameless Grills

Square grills for entire REV Series



Paintable

GHT/CT-4 Series



Speaker Type:
Woofers:
Tweeter:
Power:
Impedance:
Freq Response:
Sensitivity:
EQ Adjustments:
Grill Type:

GHT-55P

In-wall LCR
(2) 5.25" injected poly
1" silk soft dome
100 watts
8 Ω
40 - 20k Hz (+/-3 dB)
90 dB
Tweeter & woofer -3, 0, +3
Ghost style, frameless
black and white included
14.1" (359mm) H, 8.5" (216mm) W,
3.6" (92mm) D
13" (330mm) H, 7.5" (191mm) W

Finish Dims:

Cutout Dims:

Family:



GHT-SUR-P

In-wall surround
6.5" injected poly
(2) 1" silk soft dome
125 watts
8 Ω
60 - 20k Hz (+/-3 dB)
89dB
Tweeter & woofer -3, 0, +3
Ghost style, frameless
black and white included
17" (432mm) H, 9.3" (237mm) W,
3.9" (99mm) D
15.8" (402mm) H, 8" (203mm) W



GHT-66P

In-wall LCR
(2) 6.5" injected poly
1" silk soft dome, waveguide
125 watts
8 Ω
60 - 20kHz (+/-3 dB)
91 dB
Tweeter & woofer -3, 0, +3
Ghost style, frameless
black and white included
20.1" (511mm) H, 9.1" (231mm) W, 3.7"
(94mm) D
18.9" (480mm) H, 8" (203mm) W



In-Ceiling Subwoofers



QUICK CONNECT
COMPATIBLE

Speaker Type:
Woofers:
Power:
Impedance:
Freq Response:
Sensitivity:
Grill Type:

BANDPASS SUBWOOFER

Bandpass subwoofer
12" aluminum
350 watts
4 Ω
35 - 120 Hz (+/-3 dB)
88dB
Ghost style, frameless

Finish Dims:

17" (432mm) H, 17" (432mm) W,
11" (279mm) D

Family:

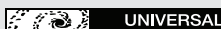

Optional

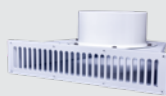

Toe Kick
BP-KICK-SET
White



Square Grill
Paintable

Speaker Type:
Driver:
Power:
Impedance:
Freq Response:
Max dB Output:
Grill Type:
Tweeter:
Weight:
Depth:
Cut Out Diameter:
Finish Diameter:

IC-SUB-8 PAIRS WITH D16 AMPLIFIER

In-Ceiling Subwoofer
8" Polypropylene
75-150W
8 Ω
38-140Hz
98
Ghost style, frameless
None
6.7 lbs
7.9" (201 mm)
9.4" (238 mm)
10.6" (269 mm)

Family:





CSUB-12

Speaker Type: Powered subwoofer
Enclosure Design: Dual passive radiators tuned enclosure.
Driver: 12" polymer bonded cellulose
Power: 350 watts internal amplifier
Frequency Range, Crossover: 20-200Hz (+/-3 dB)
 40-200Hz continuously variable low pass
Peak Rating: 550 W
Boost: 8dB@40Hz
Inputs: 1) RCA L/R 2) LFE 3) High Level Input
Grill Type: Black cloth
Cabinet Dimensions: 14.9" (379mm) H, 15.2" (386mm) W, 15.8" (402mm) D
Certifications: CE, RCM, TUV, FCC
Cabinet Finish: Black semi-gloss
Family:



CSUB-10

Speaker Type: Powered subwoofer
Enclosure Design: Dual passive radiators tuned enclosure.
Driver: 10" polymer bonded cellulose
Power: 250 watts internal amplifier
Frequency Range, Crossover: 25-200Hz (+/-3 dB)
 40-200Hz continuously variable low pass
Peak Rating: 450 W
Boost: 9dB@35Hz
Inputs: 1) RCA L/R 2) LFE 3) High Level Input
Grill Type: Black cloth
Cabinet Dimensions: 13.1" (333mm) H, 13.4" (341mm) W, 13.9" (353mm) D
Certifications: CE, RCM, TUV, FCC
Cabinet Finish: Black semi-gloss



CSUB-8

Speaker Type: Powered subwoofer
Enclosure Design: (2) passive radiators tuned enclosure.
Driver: 8" polymer bonded cellulose
Power: 150 watts internal amplifier
Frequency Range, Crossover: 28-200Hz (+/-3 dB)
 40-200Hz continuously variable low pass
Peak Rating: 240 W
Boost: 8dB@40Hz
Inputs: 1) RCA L/R 2) LFE 3) High Level Input
Grill Type: Black cloth
Cabinet Dimensions: 11.8" (300mm) H, 11.9" (303mm) W, 12.6" (320mm) D
Certifications: CE, RCM, TUV, FCC
Cabinet Finish: Black semi-gloss



SS-12

Speaker Type: Front firing, slot port
Driver: 12" coated cellulose composite
Power: 250 watt internal amplifier
Frequency Range, Crossover: 25 - 140 Hz (+/-3 dB)
 40-200 Hz continuously variable low pass
Peak Rating: 420 W
Inputs: 1) RCA L/R 2) LFE 3) High Level Input
Grill Type: Black cloth
Cabinet Dimensions: 18.5" (470mm) H (including feet)
 15" (381mm) W
 17" (432mm) D (including grill and amp)
Certifications: CE, RCM, TUV, FCC
Finish: Black, matte paint, textured vinyl
Family:



SS-10

Speaker Type: Front firing, slot port
Driver: 10" coated cellulose composite
Power: 150 watt internal amplifier
Frequency Range, Crossover: 30 - 150 Hz (+/-3 dB)
 40-200 Hz continuously variable low pass
Peak Rating: 250 W
Inputs: 1) RCA L/R 2) LFE 3) High Level Input
Grill Type: Black cloth
Cabinet Dimensions: 16" (407mm) H (including feet)
 13.4" (340mm) W
 16" (406mm) D (including grill and amp)
Certifications: CE, RCM, TUV, FCC
Finish: Black, matte paint, textured vinyl

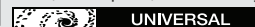

SS-8

Speaker Type: Front firing, slot port
Driver: 8" coated cellulose composite
Power: 100 watt internal amplifier
Frequency Range, Crossover: 33 - 190 Hz (+/-3 dB)
 40-200 Hz continuously variable low pass
Peak Rating: 160 W
Inputs: 1) RCA L/R 2) LFE 3) High Level Input
Grill Type: Black cloth
Cabinet Dimensions: 14.5" (368mm) H (including feet)
 12" (305mm) W
 14" (356mm) D (including grill and amp)
Certifications: CE, RCM, TUV, FCC
Finish: Black, matte paint, textured vinyl



CSUB Series

SS Series

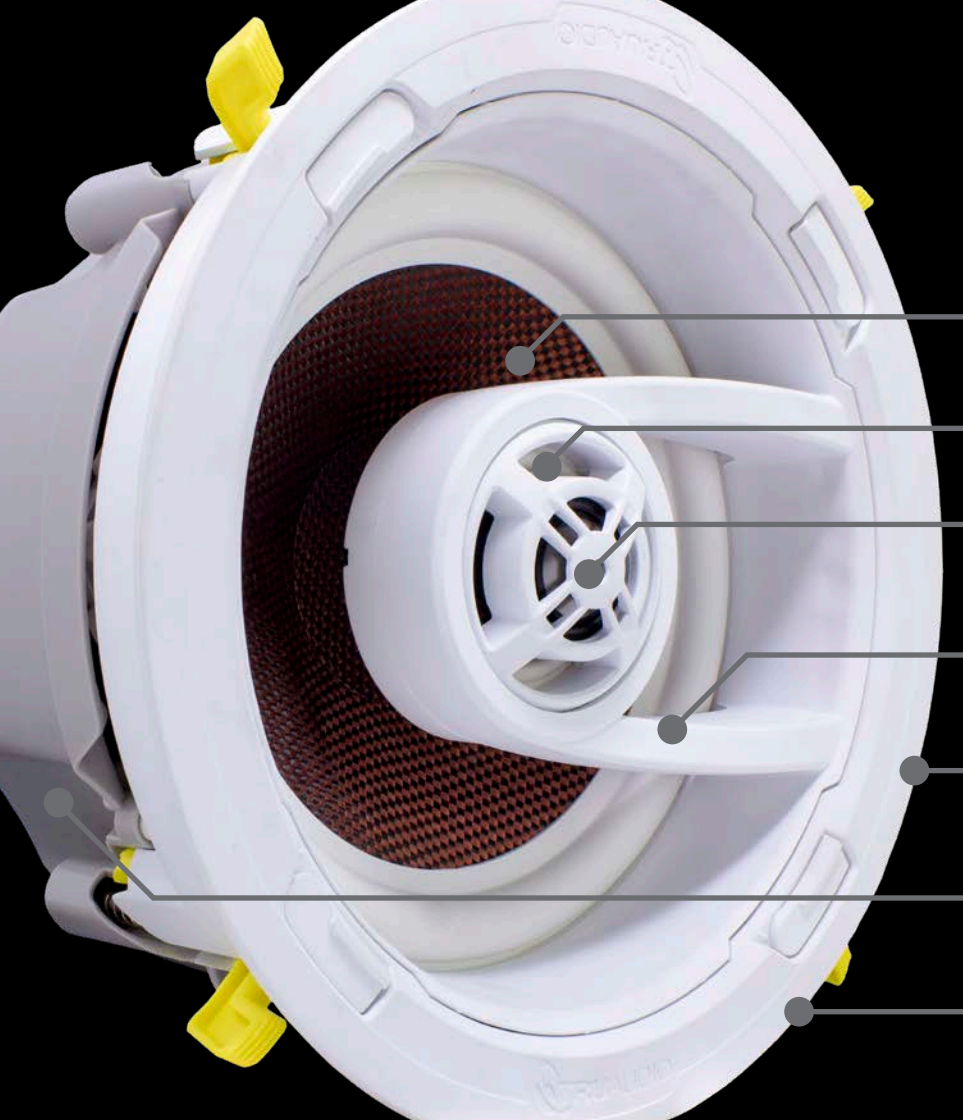

7" & 9" DRIVERS

3-WAY DESIGN
9" MODELS ONLY

DIRECTIONAL TWEETER

TWEETER BRIDGE
HANDLE

1 RING FOR BOTH SIZES
RC-879

PROTECTIVE BACKBOX

40% SMALLER REVEAL



G91

Speaker Type: In-ceiling, 3 way
Woofer: 9" carbon fiber
Midrange: 3" carbon fiber
Tweeter: 1" titanium, swivel
Power: 25-175W
Impedance: 8Ω
Frequency Response: 32-20kHz
Sensitivity: 91dB
Grill Type: Microperf, frameless
Speaker Wire Connector: Quick Connect & Gold binding post
Finish Dimensions: Diameter: 10.51" (267mm)
 Depth: 6" (152mm)
Cutout Dimensions: 9.9" (251mm)
Rough-in Ring: RC-879

Family: GRAND CANYON



G92

Speaker Type: In-ceiling, 3 way
Woofer: 9" white polypropylene
Midrange: 3" polypropylene
Tweeter: 1" silk dome, swivel
Power: 25-150W
Impedance: 8Ω
Frequency Response: 34-20kHz
Sensitivity: 90dB
Grill Type: Microperf, frameless
Speaker Wire Connector: Quick Connect & Gold binding post
Finish Dimensions: Diameter: 10.51" (267mm)
 Depth: 6" (152mm)
Cutout Dimensions: 9.9" (251mm)
Rough-in Ring: RC-879

Family: POWELL



G71

Speaker Type: In-ceiling, 2 way
Woofer: 7" carbon fiber

Tweeter: 1" titanium, swivel
Power: 25-150W
Impedance: 8Ω
Frequency Response: 36-20kHz
Sensitivity: 90dB
Grill Type: Microperf, frameless
Speaker Wire Connector: Quick Connect & Gold binding post
Finish Dimensions: Diameter: 10.51" (267mm)
 Depth: 3.9" (100mm)
Cutout Dimensions: 9.9" (251mm)
Rough-in Ring: RC-879

Family: GRAND CANYON



G72

Speaker Type: In-ceiling, 2 way
Woofer: 7" white polypropylene

Tweeter: 1" silk dome, swivel
Power: 25-125W
Impedance: 8Ω
Frequency Response: 38-20kHz
Sensitivity: 88dB
Grill Type: Microperf, frameless
Speaker Wire Connector: Quick Connect & Gold binding post
Finish Dimensions: Diameter: 10.51" (267mm)
 Depth: 3.9" (100mm)
Cutout Dimensions: 9.9" (251mm)
Rough-in Ring: RC-879

Family: POWELL

NEW AND IMPROVED CROSSOVER



Quick. Easy. Secure.

Simply connect speaker cable to the rough-in ring terminals during pre-wire. When it's time to install the speaker, use the Quick Connect™ cable to tether to the speaker's Quick Connect.



New Toolless Design

The Ghost series incorporates TruGrip™ technology to streamline the installation process. TruGrip™ toolless technology is a two-step mechanical dogear ensuring the tightest grip with zero sag.



QUICK CONNECT COMPATIBLE

GD71

- Speaker Type:** In-ceiling, dual voice coil
- Woofers:** 7" carbon fiber
- Midrange:** ---
- Tweeter:** (2) 1" titanium, swivel
- Power:** 25-150W
- Impedance:** 8Ω
- Frequency Response:** 36-20kHz
- Sensitivity:** 90dB
- Grill Type:** Microperf, frameless
- Speaker Wire Connector:** Quick Connect & Gold binding post
- Finish Dimensions:** Diameter: 10.51" (267mm)
Depth: 3.9" (100mm)
- Cutout Dimensions:** 9.9" (251mm)
- Rough-in Ring:** RC-879
- Family:** GRAND CANYON



QUICK CONNECT COMPATIBLE

GD72

- Speaker Type:** In-ceiling, dual voice coil
- Woofers:** 7" white polypropylene
- Midrange:** ---
- Tweeter:** (2) 1" silk dome, swivel
- Power:** 25-125W
- Impedance:** 8Ω
- Frequency Response:** 38-20kHz
- Sensitivity:** 88dB
- Grill Type:** Microperf, frameless
- Speaker Wire Connector:** Quick Connect & Gold binding post
- Finish Dimensions:** Diameter: 10.51" (267mm)
Depth: 3.9" (100mm)
- Cutout Dimensions:** 9.9" (251mm)
- Rough-in Ring:** RC-879
- Family:** POWELL

Optional:



ELEMENT GRILLS
Weatherproof Grills
Treated with Weatherloc™
Technology by Sealoc
GR-ELEMENT-79



Black Micro-Perf Frameless Grills

Square grills for entire Ghost Series



Paintable

NEW AND IMPROVED CROSSOVER

Phantom Series

Phantom Series



QUICK CONNECT COMPATIBLE

PG-8

Speaker Type: In-ceiling, 2 way
Woofers: 8" glass fiber
Tweeter: 1" titanium
Power: 140 watts
Impedance: 8 Ω
Freq Response: 39 - 20k Hz (+/-3 dB)
Sensitivity: 90 dB
Grill Type: Ghost style, frameless
Grill Material: Powder coated galvanized steel
Finish Dims: 10.4" (265mm) diameter
 3.9" (99mm) deep
Cutout Dims: 9.7" (244mm) diameter

Family: MEAD



QUICK CONNECT COMPATIBLE

PG-6

Speaker Type: In-ceiling, 2 way
Woofers: 6.5" glass fiber
Tweeter: 1" titanium
Power: 125 watts
Impedance: 8 Ω
Freq Response: 47 - 20k Hz (+/-3 dB)
Sensitivity: 90 dB
Grill Type: Ghost style, frameless
Grill Material: Powder coated galvanized steel
Finish Dims: 8.9" (226mm) diameter
 3.6" (91mm) deep
Cutout Dims: 8.2" (208mm) diameter

Family: MEAD



QUICK CONNECT COMPATIBLE

PDP-8

Speaker Type: In-ceiling, dual voice coil
Woofers: 8" injected polypropylene
Tweeter: (2) 1" silk soft dome
Power: 120 watts
Impedance: 8 Ω
Freq Response: 50 - 20k Hz (+/- 3dB)
Sensitivity: 89 dB
Grill Type: Ghost style, frameless
Grill Material: Powder coated galvanized steel
Finish Dims: 10.4" (265mm) diameter
 4" (101mm) deep
Cutout Dims: 9.7" (244 mm) diameter

Family: POWELL

Optional:



ELEMENT GRILLS
 Weatherproof Grills
 Treated with Weatherloc™
 Technology by Sealoc
 GR-ELEMENT-6/8

Square grills
 for entire Phantom and
 Shadow Series



Paintable



QUICK CONNECT COMPATIBLE

PP-8

Speaker Type: In-ceiling, 2 way
Woofers: 8" injected polypropylene
Tweeter: 1" silk soft dome
Power: 120 watts
Impedance: 8 Ω
Freq Response: 42 - 20k Hz (+/-3 dB)
Sensitivity: 90 dB
Grill Type: Ghost style, frameless
Grill Material: Powder coated galvanized steel
Finish Dimensions: 10.4" (265mm) diameter
 4" (101mm) deep
Cutout Dimension: 9.7" (244mm) diameter

Family: POWELL



QUICK CONNECT COMPATIBLE

PP-6

Speaker Type: In-ceiling, 2 way
Woofers: 6.5" injected polypropylene
Tweeter: 1" silk soft dome
Power: 90 watts
Impedance: 8 Ω
Freq Response: 52 - 20k Hz (+/-3 dB)
Sensitivity: 90 dB
Grill Type: Ghost style, frameless
Grill Material: Powder coated galvanized steel
Finish Dimensions: 8.9" (226mm) diameter
 3.4" (86mm) deep
Cutout Dimension: 8.2" (208mm) diameter

Family: POWELL



QUICK CONNECT COMPATIBLE

PP-4

Speaker Type: In-ceiling, 2 way
Woofers: 4" injected polypropylene
Tweeter: 0.75" silk soft dome
Power: 55 watts
Impedance: 8 Ω
Freq Response: 65 - 20k Hz (+/-3 dB)
Sensitivity: 89 dB
Grill Type: Ghost style, frameless
Grill Material: Powder coated galvanized steel
Finish Dimensions: 7.5" (190mm) diameter
 2.8" (71mm) deep
Cutout Dimension: 6.6" (167mm) diameter

Family: POWELL



QUICK CONNECT COMPATIBLE

PDP-6

Speaker Type: In-ceiling, dual voice coil
Woofers: 6.5" injected polypropylene
Tweeter: (2) 0.75" silk soft dome
Power: 100 watts
Impedance: 8 Ω
Freq Response: 55 - 20k Hz (+/-3 dB)
Sensitivity: 89 dB
Grill Type: Ghost style, frameless
Grill Material: Powder coated galvanized steel
Finish Dimensions: 8.9" (226mm) diameter
 3.4" (86mm) deep
Cutout Dimension: 8.2" (208mm) diameter

Family: POWELL



CC
QUICK CONNECT
COMPATIBLE







CC
QUICK CONNECT
COMPATIBLE





TruWhite Micro-Perf Frameless Grill



Shadow Series



SP-8
Speaker Type: In-ceiling, 2 way
Woofers: 8" polypropylene
Tweeter: 1" mylar
Power: 90 watts
Impedance: 8 Ω
Freq Response: 38 - 20k Hz (+/-3 dB)
Sensitivity: 89 dB
Grill Type: Ghost style, frameless
Grill Material: Powder coated galvanized steel
Finish Dims: 10.4" (265mm) diameter
 3.6" (91mm) deep
Cutout Dims: 9.7" (244mm) diameter
Family:  ARCHES 

SP-6
Speaker Type: In-ceiling, 2 way
Woofers: 6.5" polypropylene
Tweeter: 0.75" mylar
Power: 75 watts
Impedance: 8 Ω
Freq Response: 53 - 20k Hz (+/-3 dB)
Sensitivity: 89 dB
Grill Type: Ghost style, frameless
Grill Material: Powder coated galvanized steel
Finish Dims: 8.9" (226mm) diameter
 3.4" (86mm) deep
Cutout Dims: 8.2" (208mm) diameter
Family:  ARCHES 



IWP-6
Speaker Type: In-wall, 2 way
Woofers: 6.5" Injected polypropylene
Tweeter: 1" silk soft dome, swivel
Power: 100 watts
Impedance: 8 Ω
Freq Response: 55 - 20k Hz (+/-3 dB)
Sensitivity: 90 dB
Grill Type: Micromesh, aluminum
Finish Dims: 12.1" (308mm) H, 8.8" (224mm) W,
 3" (76mm) D
Cutout Dims: 10.9" (277mm) H, 7.4" (188mm) W
Family:  BRYCE 

GPW-8
Speaker Type: In-wall, 2 way
Woofers: 8" white polypropylene
Tweeter: 1" silk soft dome/Changable Waveguide
Power: 125 watts
Impedance: 8 Ω
Freq Response: 40 - 20kHz (+/-3 dB)
Sensitivity: 90dB
Grill Type: Tweeter & woofer +3, 0, -3
Grill Material: Ghost Style, frameless
Finish Dims: 14.6" (371mm) H, 10.4" (264mm) W,
 3.9" (99mm) D
Cutout Dims: 9.3" (236mm) H, 13.4" (340mm) W
Family:  POWELL 

GPW-6
Speaker Type: In-wall, 2 way
Woofers: 6.5" white polypropylene
Tweeter: 1" silk soft dome/Changable Waveguide
Power: 100 watts
Impedance: 8 Ω
Freq Response: 45 - 20kHz (+/-3 dB)
Sensitivity: 89dB
Grill Type: Tweeter & woofer +3, 0, -3
Grill Material: Ghost Style, frameless
Finish Dims: 12.9" (328mm) H, 9.1" (233mm) W,
 3.9" (99mm) D
Cutout Dims: 8" (203mm) H, 11.6" (295mm) W
Family:  POWELL 

IWP / GPW



IMAGE COURTESY OF SUMMIT SECURITY

CUSTOM LENGTH SOUNDBARS



Type: Low profile custom length LCR, LR or CC soundbar
Woofer: (3) 4.5" carbon fiber
Tweeter: (3) 1" titanium
Passive Radiator: (3) 4.5" carbon fiber
Power: 125 watts (per ch) RMS
Impedance: 8 Ω
Freq Response: 90Hz - 22kHz (+/-3 dB)
Sensitivity: 89 dB
Grill Type: Cloth/aluminum black (silver optional)
Soundbar Width: 62" to 82"
Dimensions: 6.1" (155mm) H, 2.4" (61mm) D, 62" (1575mm) to 82" (2083mm)
Custom cut length
Family: GRAND CANYON

SB-CUSTOM-SC
Type: Low profile custom length LCR, LR or CC soundbar
Woofer: (3) 4.5" carbon fiber
Tweeter: (3) 1" titanium
Passive Radiator: (3) 4.5" carbon fiber
Power: 125 watts (per ch) RMS
Impedance: 8 Ω
Freq Response: 90Hz - 22kHz (+/-3 dB)
Sensitivity: 89 dB
Grill Type: Cloth/aluminum black (silver optional)
Soundbar Width: 41.5" to 62"
Dimensions: 6.1" (155mm) H, 2.4" (61mm) D, 41.5" (1054mm) to 62" (1575mm)
Custom cut length
Family: GRAND CANYON

SB-CUSTOM-LP
Type: Low profile custom length LCR, LR or CC soundbar
Woofer: (3) 4.5" injected polypropylene
Tweeter: (3) 1" silk soft dome
Passive Radiator: (3) 4.5" injected polypropylene
Power: 100 watts (per ch) RMS
Impedance: 8 Ω
Freq Response: 110Hz - 20kHz (+/-3 dB)
Sensitivity: 88 dB
Grill Type: Cloth/aluminum black (silver optional)
Soundbar Width: 62" to 82"
Dimensions: 6.1" (155mm) H, 2.4" (61mm) D, 62" (1575mm) to 82" (2083mm)
Custom cut length
Family: POWELL

SB-CUSTOM-SP
Type: Low profile custom length LCR, LR or CC soundbar
Woofer: (3) 4.5" injected polypropylene
Tweeter: (3) 1" silk soft dome
Passive Radiator: (3) 4.5" injected polypropylene
Power: 100 watts (per ch) RMS
Impedance: 8 Ω
Freq Response: 110 Hz - 20kHz (+/-3 dB)
Sensitivity: 88 dB
Grill Type: Cloth/aluminum black (silver optional)
Soundbar Width: 41.5" to 62"
Dimensions: 6.1" (155mm) H, 2.4" (61mm) D, 41.5" (1054mm) to 62" (1575mm)
Custom cut length
Family: POWELL



CUSTOM LENGTH TO MATCH ANY SCREEN



PATENT PENDING

Front Wire Pass-Through



SB-CUSTOM-TVB

Flatscreen Mounting Bracket
 Mount any Custom Length Soundbar to any flatscreen TV

CUSTOM POWERED SOUNDBAR



Optional wireless subwoofer receiver. Seamlessly pair any TruAudio subwoofer to the Custom Powered Soundbar.

SB-CPSB-C

Type: Low profile custom length powered soundbar
Woofer: (2) 4.5" carbon fiber
Tweeter: (2) 1" titanium
Passive Radiator: (2) 4.5" carbon fiber
Power: 110-240V, 50-60Hz
Impedance: 8 Ω
Freq Response: 70Hz - 22kHz (+/-3 dB)
Speaker Output: Internal amplifier, 2x30W
Inputs: Toslink (optical), Bluetooth, AUX 3.5mm analog
Bluetooth Version: v.4.2
Grill Type: Cloth/aluminum black (silver optional)
Soundbar Height: 6.1" (155mm)
Soundbar Depth: 2.4" (61mm) D,
Soundbar Width: 42.9"-57.9" (1090-1473mm) or 61.0-68" (1549-1727mm)

Family: GRAND CANYON

SB-CPSB-P

Type: Low profile custom length powered soundbar
Woofer: (2) 4.5" polypropylene
Tweeter: (2) 1" silk dome
Passive Radiator: (2) 4.5" polypropylene
Power: 110-240V, 50-60Hz
Impedance: 8 Ω
Freq Response: 70Hz - 22kHz (+/-3 dB)
Speaker Output: Internal amplifier, 2x30W
Inputs: Toslink (optical), Bluetooth, AUX 3.5mm analog
Bluetooth Version: v.4.2
Grill Type: Cloth/aluminum black (silver optional)
Soundbar Height: 6.1" (155mm)
Soundbar Depth: 2.4" (61mm) D,
Soundbar Width: 42.9"-57.9" (1090-1473mm) or 61.0-68" (1549-1727mm)

Family: POWELL



Analog & Digital Inputs | Bluetooth
 IR Learn | Remote Control
 Built-in Wireless Sub Transmitter



SB-SLIM-44P

Type: Low profile, LCR soundbar
Woofer: (3) 4.5" injected polypropylene
Tweeter: (3) 1" silk soft dome
Passive Radiator: (3) 4.5" injected polypropylene
Power: 100 watts (per ch) RMS
Impedance: 8 Ω
Freq Response: 110 Hz - 20kHz (+/-3 dB)
Sensitivity: 88 dB
Grill Type: Cloth/aluminum black (silver optional)
Dimensions: 6.1" (155mm) H, 2.4" (61mm) D, 44" (1118mm) W

Family: POWELL



Ships Same Day



Front Wire Pass-Through



SB-CUSTOM-TVb
 Flatscreen Mounting Bracket
 Mount any Custom Length
 Soundbar to any flatscreen TV

Acoustiscape Series



AS-3

Speaker Type: Landscape outdoor, 2-way
Woofer: 8" molded polypropylene
Tweeter: 1" Silk soft dome
Power: 64 watts
Impedance: 8 Ω or 70V/100V
70v Taps: 4, 8, 16, 32, 64W
100v Taps: 8-64W selectable
Freq Response: 40 - 20k Hz (+/- 3dB)
Sensitivity: 88 dB
Grill Type: Aluminum mesh
Mounting: Ground stake, (Optional wall base)
Finish Dims: 10" (254mm) L, 8.5" (216mm) Diameter

Family:



AS-2

Speaker Type: Landscape outdoor, 2-way
Woofer: 6.5" molded polypropylene
Tweeter: 1" Silk soft dome
Power: 50 watts
Impedance: 8 Ω or 70V/100V
70v Taps: 3, 6, 13, 25, 50W
100v Taps: 6W - 50W selectable
Freq Response: 60 - 20k Hz (+/- 3dB)
Sensitivity: 88 dB
Grill Type: Aluminum mesh
Mounting: Ground stake, (Optional wall base)
Finish Dims: 9.4" (239mm) L, 7.7" (196mm) Diameter



AS-1

Speaker Type: Landscape outdoor, 2-way
Woofer: 4.5" molded polypropylene
Tweeter: 0.75" silk soft dome
Power: 30 watts
Impedance: 8 Ω or 70V/100V
70v Taps: 2, 4, 8, 15, 30W
100v Taps: 6W - 30W selectable
Freq Response: 80 - 20k Hz (+/- 3dB)
Sensitivity: 85 dB
Grill Type: Aluminum mesh
Mounting: Ground stake, (Optional wall base)
Finish Dims: 6.9" (175mm) L, 5.4" (137mm) Diameter



AS-360

Speaker Type: Landscape outdoor, 2-way
Woofer: 6.5" molded polypropylene
Tweeter: (3) 1" silk soft dome
Power: 50 watts
Impedance: 8 Ω or 70V/100V
70v Taps: 3, 6, 13, 25, 50W
Freq Response: 60 - 20k Hz (+/- 3dB)
Sensitivity: 88 dB
Grill Type: Aluminum mesh
Mounting: Ground/Wall mount and stake included
Finish Dims: 8.3" (211mm) Diameter, 9.5" (241mm) H



ULTRASCAPE-PRO
Includes:

- (1) 10" Burial subwoofer
- (4) 4" Satellite speakers



ULTRAPRO+
Includes:

- (1) 10" Burial subwoofer
- (6) 4" Satellite speakers



ULTRASCAPE-PRO+ EXPANSION SYSTEM (Can only be added to ULTRASCAPE-PRO System)
Includes:

- (2) Satellite Speakers



ULTRASCAPE-PRO-T100-A.1x
Includes:

- (1) ULTRASCAPE-PRO
- (1) T100
- (1) VSSL A.1x



ULTRASCAPE-PRO-T100
Includes:

- (1) ULTRASCAPE-PRO
- (1) T100

Speaker Type: Underground subwoofer
Woofer: 10" dual voice coil high-density polypropylene
Impedance: 11Ω+11Ω
Freq Response: 45 - 200 Hz (+/-3 dB)
Sensitivity: 89 dB 1w/1m
Input: 2 channel audio signal in
Output: 2 channel signal out
Enclosure: Fiberglass reinforced plastic
Dimensions: 12.68" x 16.54"

Family:



Speaker Type: 2-way outdoor landscape speaker
Woofer: 4" high-density polypropylene
Tweeter: 0.75" all-weather PEI
Impedance: 16Ω
Freq Response: 70 - 21K Hz (+/-3 dB)
Sensitivity: 88 dB @ 1w/1m
Grill Type: Aluminum
Dimensions: Diameter: 5", Length: 7", Height: 7.7" Height with stake 11"

Family:





IP66



IP66



IP66

ST-12PRO

Speaker Type: Underground Subwoofer
Woofer: 12" injected polypropylene
Power: 400 watts
Impedance: 4 Ω or 70V
70v Taps: 200W
Freq Response: 30 - 120 Hz (+/- 3dB)
Sensitivity: 89 dB
Colors: Green
Finish Dims: 17.22" (437mm) L, 17.22" (437mm) W, 19.87" (505mm) H w/port

Family:



ST-10PRO

Speaker Type: Underground Subwoofer
Woofer: 10" injected polypropylene
Power: 250 watts
Impedance: 4 Ω

Freq Response: 40 - 85 Hz (+/- 3dB)
Sensitivity: 88 dB
Colors: Yellow
Finish Dims: 15.2" (386mm) L, 15.2" (386mm) W, 19.87" (505mm) H w/port



HS-SUB-12BR/TN

Speaker Type: Outdoor subwoofer
Woofer: 12" polypropylene
Power: 350 watts
Impedance: 4 Ω/70v
70v Taps: 200 watts
Freq Response: 36 - 150 Hz
Sensitivity: 90dB
Colors: Brown or Tan
Finish Dims: 16.5" (419mm) H, 15.6" (396mm) W, 15.6" (396mm) D



**SubTerrain PRO /
Hardscape Sub**

PREFERRED PACKAGES



SUBT12-PAKLEA-AS2-8



SUBT-PAKLEA-AS2-6

**FREE
SYSTEM DESIGN SERVICES**

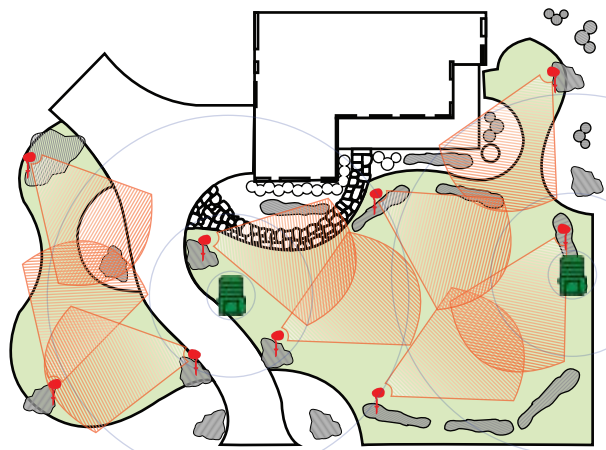

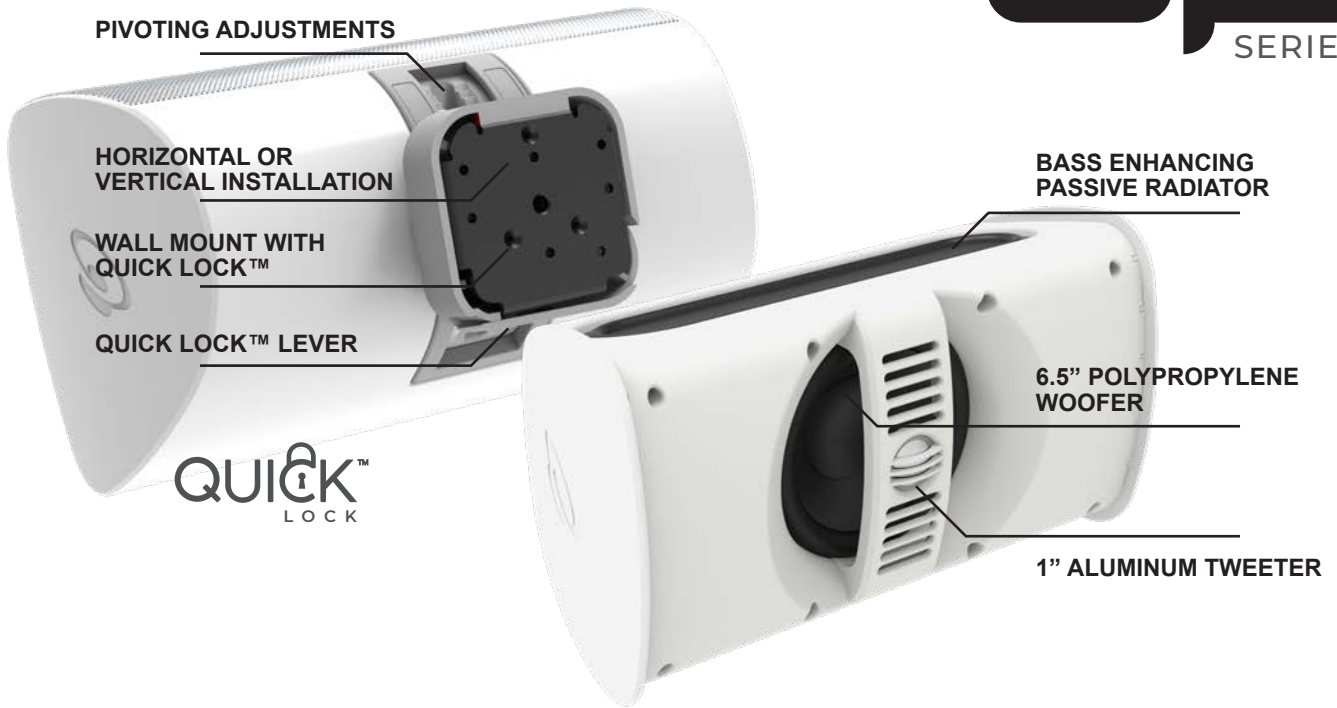

OP6-WT | OP6-BK

Speaker Type: Outdoor, 2-way

Woofers: 6.5" polypropylene

Passive Radiator: Bass enhancing radiator

Tweeter: 1" aluminum

Power: 25-150W

Impedance: 8Ω

Frequency Response: 65-20kHz

Sensitivity: 89dB

Grill Type: Aluminum microperforated

Speaker Wire Connector: Quick Lock™ technology

Finish Dimensions:
 W: 14.5" (368mm)
 H: 8.3" (211mm)
 D: 8.9" (226mm)



Rock Series / OL Series



IP66

RK-8 GY/TN

Speaker Type: Outdoor, 2 way rock speaker

Woofers: 8" polypropylene

Tweeter: 1" titanium

Power: 150 watts

Impedance: 8Ω

Freq Response: 40 - 20k Hz (+/- 3dB)

Sensitivity: 90 dB

Grill Type: Rock-shaped micromesh

Colors Available: Gray, tan

Cabinet Size:
 11.8" (300mm) H
 15" (381mm) W
 12.3" (312mm) D

Family:



IP66

OL-5 WT/BK

Speaker Type: Outdoor, 2 way

Woofers: 5.25" polypropylene

Tweeter: 0.75" titanium

Power: 80 watts

Impedance: 8Ω

Freq Response: 60 - 20k Hz (+/- 3dB)

Sensitivity: 89 dB

Grill Type: Aluminum mesh

Colors Available: Black, white

Cabinet Size:
 10.3" (262mm) H
 7.3" (185mm) W
 6.5" (165mm) D



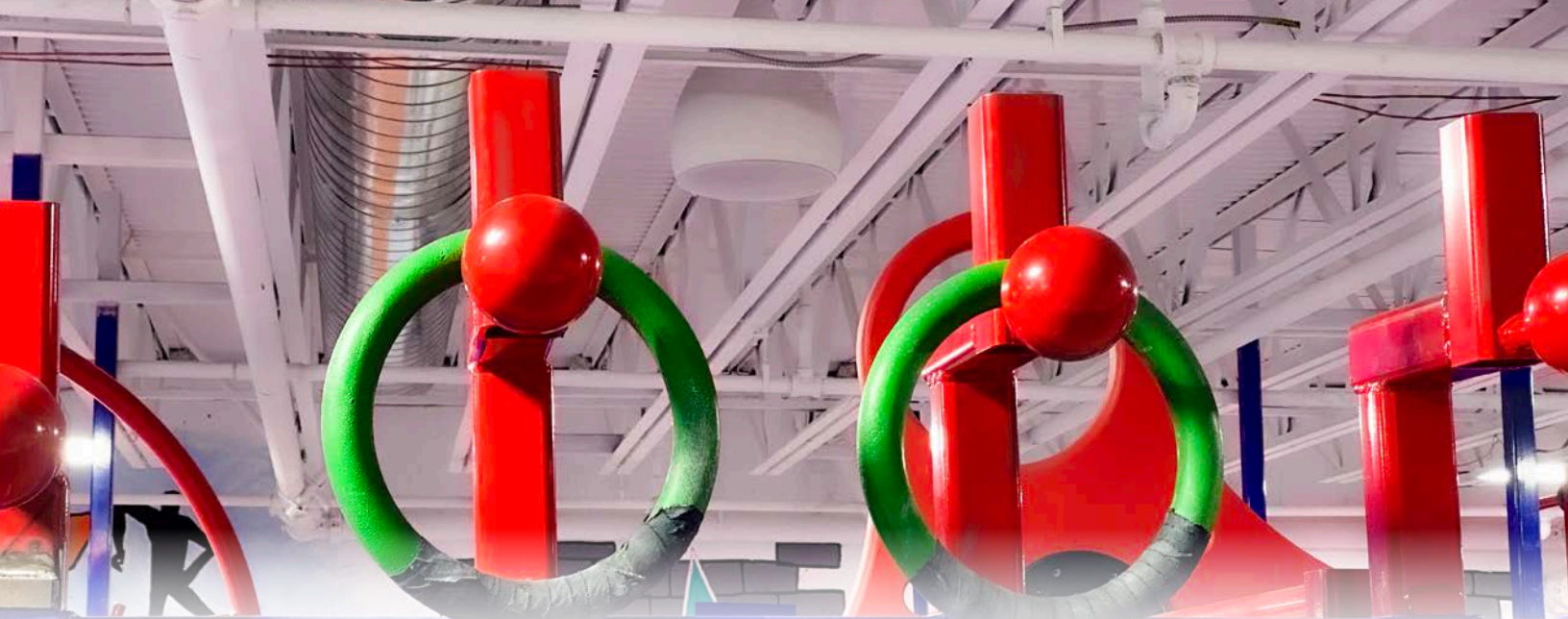

BD-8 WT/BK



Speaker Type: Pendant, 2-way
Woofers: 8" molded polypropylene
Tweeter: 1" Silk soft dome
Power: 125 watts
Impedance: 8 Ω or 70v/100V
70v Taps: 4, 8, 15, 30, 60W
100v Taps: 8, 15, 30, 60W
Freq Response: 42 - 20k Hz (+0/-3 dB)
Sensitivity: 90 dB
Grill Type: Aluminum mesh
Colors Available: Black, white
Mounting: Gripple with cable
Finish Dims: Height: 12.6" (320mm)
 Width: 12.3" (312mm)
 Depth: 17" (432mm)

Family:



OL-70v-6BK/WT

Outdoor 70v
 6.5" polypropylene
 1" silk
 30 watts
 70v/100v
 2, 4, 8, 15, 30W
 4, 8, 15, 30W
 60 - 20k Hz (+/-3 dB)
 86 dB
 Aluminum mesh
 Black, White
 U bracket
 11.9" (303mm) diameter
 8.5" (215mm) deep
 7.5" (191mm) diameter



Back Box Included

CL-70v-6

In-Ceiling 70v 2-way
 6.5" polypropylene
 0.75" PEI
 60 watts
 8 Ω or 70v/100v
 2.5, 5, 10, 15, 25W
 5, 10, 15, 25W
 60 - 20k Hz (+/-3 dB)
 86 dB
 Aluminum mesh
 White

9.5" (241mm) diameter
 5.9" (150mm) deep
 8.3" (211mm) diameter



Metal Back Box Included

CL-70v-6UL



In-Ceiling 70v 2-way
 6.5" polypropylene
 0.75" PEI
 60 watts
 8 Ω or 70v/100v
 2.5, 5, 10, 15, 25W
 5, 10, 15, 25W
 60 - 20k Hz (+/-3 dB)
 88 dB
 Ghost style, frameless
 White

10.4" (264mm) diameter
 9" (229mm) deep
 8.8" (224mm) diameter



Commercial



VCS-100-AIW

Slider type control
 100 watt stereo
 volume control
 Impedance matching
 Décor style faceplate
 Colors: white, almond,
 ivory

VCK-100-AIW

Rotary knob type
 control
 100 watt stereo
 volume control
 Impedance matching
 Décor style faceplate
 Colors: white, almond,
 ivory



VCK-70v-100AIW

Rotary knob type
 control
 volume control with
 25W-100W max
 speaker load at 70v
 Décor style faceplate
 Colors: white, almond,
 ivory

Volume Controls



16 CHANNEL AMPLIFIER 8 SUBWOOFER OUTPUTS



FEATURES

- 8 SUBWOOFER RCA OUTPUTS PAIRS SEAMLESSLY WITH IC-SUB-8
- GAIN KNOB PER ZONE
- LINE IN PER ZONE
- STEREO/BRIDGE SWITCH PER PAIR
- SPEAKER LEVEL SUBWOOFER OUT WITH ADJUSTABLE SUBWOOFER CROSSOVER



QUICK CONNECT
COMPATIBLE

D16

Channels: 16 channels, 8 zones Class D Amplifier
Subwoofer Outputs: 8 RCA outputs
Subwoofer Crossover: 40-140Hz
Power Output, Continuous: 75 watts/ch @ 8Ω all channels driven
 150 watts/ch @ 4Ω
 150 watts/ch @ 8Ω
Bridged Power Output: AC 100-120V 60Hz / AC220-240V 50Hz
Power Requirements: Manual Switching
 A&B Bus in and out,
Inputs: 4-8 Ω
Impedance: 4-8 Ω
Dimensions: 4.2" (105mm)H,
 16.8" (427mm)W,
 13.5" (343mm) D (w/RCA ports)
Weight: 35.15 lbs
Rack Mount: Includes rack ears, 2U
Certifications: CE, CB, NRT, FCC, CE-EMC, ERP

Family: UNIVERSAL

IC-SUB-8

Speaker Type: In-Ceiling Subwoofer
Driver: 8" Polypropylene
Power: 75-150W
Impedance: 8Ω
Frequency Response: 38-140Hz
Max dB Output: 98
Grill Type: Ghost style, frameless
Tweeter: None
Weight: 6.7 lbs
Depth: 7.9" (201 mm)
Cut Out Diameter: 9.4" (238 mm)
Finish Diameter: 10.6" (269 mm)

Family: UNIVERSAL



AMP-3512

Channels: 12 channels, 6 zones
Power Output, Continuous: 35 watts/ch @ 8 Ω
 70 watts/ch @ 8 Ω
Bridged Power Output: 115v / 230v
Power Requirements: 2-Global Ins (BUS), 2-Global Outs (BUS),
Inputs: 6-Local Inputs
 4-8 Ω
Impedance: 3.9"(99mm)H,
Dimensions: 16.4"(417mm)W,
 14.5"(368mm) D
 27.5 lbs
Weight: Includes rack ears, 2U
 ETL, CE (or CB scheme)
Certifications:



TRU-S500DSP

Channels: Mono channel sub amplifier
Subwoofer Presets: Trident, Trunami, SubTerrain Series,
 BP-SUB-12, HS-SUB-12
Power Output, Continuous: 250 watts (RMS @ 8ohms)
 500 watts/ch @ 4 ohms
Bridged Power Output: ---
Power Requirements: 115v / 230v
 4-8 Ω
Impedance: 1.8" (46mm) H
Dimensions: 19" (483mm) W
 10.4" (264mm) D
Weight: 16 lbs.
 Includes rack ears, 1U
Certifications: EU, CE, ETL, RCM

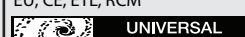

Amplifiers

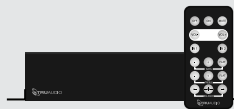

T100

Channels: 2 Channels
Power Output, Continuous: ---
 100 watts/ch @ 8 ohms
 150 watts/ch @ 4 ohms
Bridged Power Output: 275 watts @ 8 ohms
Power Requirements: 120v / 240v
Inputs: 4 - 8 Ω
Impedance: 1.75" (44mm) H
Dimensions: 7.8" (200mm) W
 10.3 (260mm)
 4.5 lbs.
Weight: CE, FCC
Certifications:

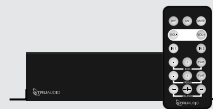
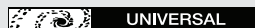

T50

Channels: 2 channels
Power Output, Continuous: ---
 50 watts/ch @ 8 ohms
 60 watts/ch @ 4 ohms
 100W @ 8 ohm / 60W @ 4 ohm
Power Requirements: 120V - 240V @ 50Hz - 60Hz A/C
 4 - 8 Ω
Impedance: 1.75" (44.5mm) H
Dimensions: 6.5" (132mm)W
 5.2" (132mm) D
 2.25 lbs
Weight: CE, FCC
Certifications:

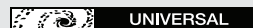

Amplifiers



RC-4

All 4" in-ceiling (round) models
One center ring, two wings,
insulation guard, wing span:
34" (864mm)
6.6" (168mm)

RC-6

All 6.5" in-ceiling (round) models,
One center ring, two wings,
insulation guard, wing span:
35.9"(912mm)
8.1" (206mm) diameter



RC-6UL

CL-70v-6UL
One center ring, two wings,
insulation guard, wing span:
35.9"(912mm)
8.8" (224mm) diameter

RC-879

All 7", 8", and 9" in-ceiling (round)
models
One center ring, two wings,
insulation guard, wing span:
37.5" (953mm)
9.75" (248mm)



RW-55

GHT-55P
Two mesh aluminum wings, one
center ring, wing span:
35.4" (899mm)
13" (330mm) H,
7.4" (188mm) W

RW-6

IWP-6
One center ring, two wings,
insulation guard, wing span:
24" (610 mm)
10.8" (274mm) H,
7.25" (184mm) W

RW-G6

GPW-6
One center ring, two wings,
insulation guard, wing span:
24" (610mm)
13.5" (343mm) H,
9.5" (241mm) W

RW-G66

GHT-66P Ghost-in-wall speaker
One center ring, two wings,
insulation guard, wing span:
40"(1016mm)
19"(483mm) H,
8"(203mm) W

RW-G8

GPW-8
Two mesh aluminum wings, one
center ring, wing span:
42" (1067mm)
13.4" (340mm) H,
9.3" (236mm) W

RW-GSUR

GHT-SUR-P Ghost HT in-wall speaker
One center ring, two wings,
insulation guard, wing span:
40"(1016 mm)
15.8"(401mm) H,
8"(203mm) W

RW-E46/26

Top and bottom and two side
frames. Adjustable for use with
either the ELITE46 or ELITE26 models.
23.5"(597mm)-36.25(921mm) H,
22.25"(565mm) W

B-6UL

CL-70v6UL
Metal cross members and open
metal ring.
25.9" (658mm) L,
14.2" (361mm) W
1.3" (33mm) D

B-70

CL-70v6 and 6.5" in-ceiling
Metal cross members and open
metal ring.
25.9" (658mm) L,
14.2" (361mm) W
1.3" (33mm) D





VSSL™

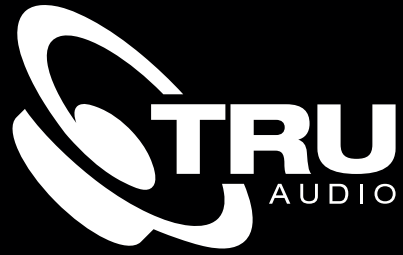

SOUNDVISION
TECHNOLOGIES

P: 888.858.1555 | E: sales@truaudio.com
192 N. Old Highway 91 Unit 1, Hurricane, Utah 84737 | www.soundvisiontech.com